

Analog Devices Welcomes Hittite Microwave Corporation

NO CONTENT ON THE ATTACHED DOCUMENT HAS CHANGED



THIS PAGE INTENTIONALLY LEFT BLANK



GaAs PHEMT MMIC MEDIUM POWER AMPLIFIER, 17.5 - 25.5 GHz

Typical Applications

The HMC442LC3B is an ideal gain block or driver amplifier for:

- Point-to-Point Radios
- Point-to-Multi-Point Radios
- LO Driver for HMC Mixers
- Military EW & ECM

Features

- Gain: 13 dB
- Saturated Power: +23 dBm @ 26% PAE
- Supply Voltage: +5V
- 50 Ohm Matched Input/Output
- RoHS Compliant 3 x 3 mm SMT package

Functional Diagram

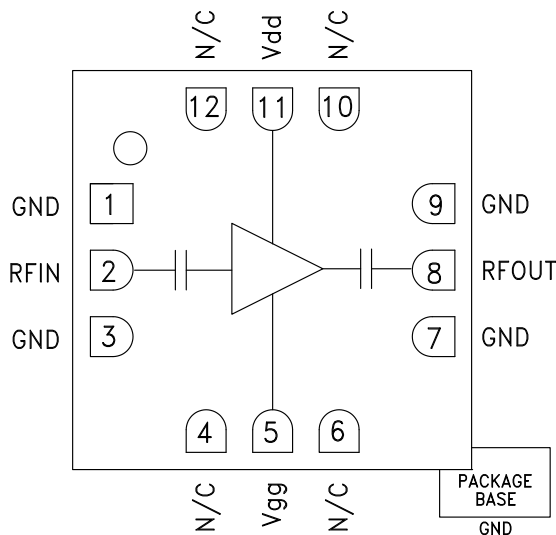

General Description

The HMC442LC3B is an efficient GaAs PHEMT MMIC Medium Power Amplifier housed in a leadless "Pb free" RoHS compliant SMT package. Operating between 17.5 and 25.5 GHz, the amplifier provides 13 dB of gain, +23 dBm of saturated power and 26% PAE from a +5V supply voltage. This 50 Ohm matched amplifier does not require any external components, making it an ideal linear gain block or driver for HMC SMT mixers. The HMC442LC3B allows the use of surface mount manufacturing techniques.

Electrical Specifications, $T_A = +25^\circ C$, $V_{dd} = +5V$, $I_{dd} = 84 mA^*$

Parameter	Min.	Typ.	Max.	Min.	Typ.	Max.	Min.	Typ.	Max.	Units
Frequency Range	17.5 - 21.0			21.0 - 24.0			24.0 - 25.5			GHz
Gain	10	13		10	13		8	11		dB
Gain Variation Over Temperature		0.02	0.03		0.02	0.03		0.02	0.03	dB/°C
Input Return Loss		10			10			5		dB
Output Return Loss		9			9			12		dB
Output Power for 1 dB Compression (P1dB)	18	21		19	22		19	22		dBm
Saturated Output Power (P _{sat})		23			23.5			23		dBm
Output Third Order Intercept (IP3)		27			26			26		dBm
Noise Figure		8			8			9		dB
Supply Current (I _{dd})(V _{dd} = 5V, V _{gg} = -1V Typ.)		84			84			84		mA

*Adjust V_{gg} between -1.5 to -0.5V to achieve I_{dd} = 84 mA typical.



**GaAs PHEMT MMIC MEDIUM
POWER AMPLIFIER, 17.5 - 25.5 GHz**

Broadband Gain & Return Loss

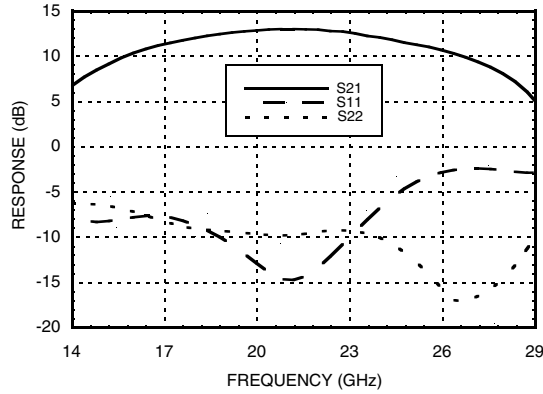

Gain vs. Temperature

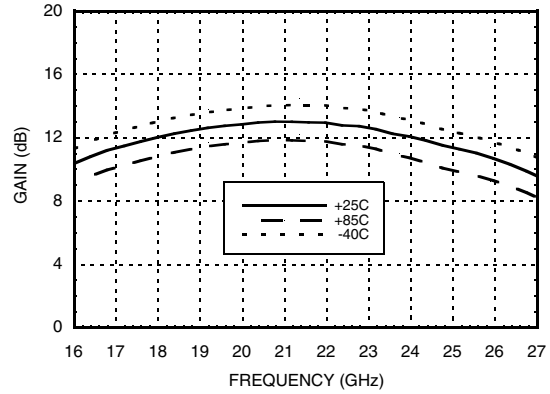

Input Return Loss vs. Temperature

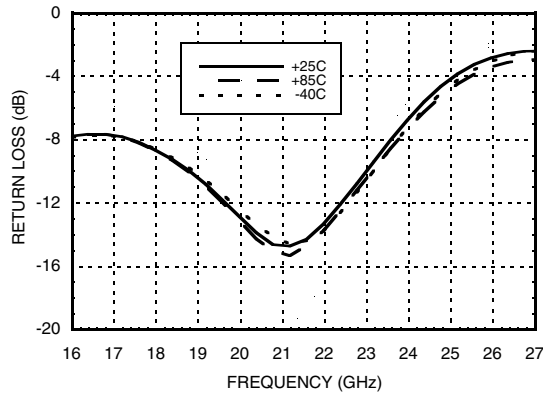

Output Return Loss vs. Temperature

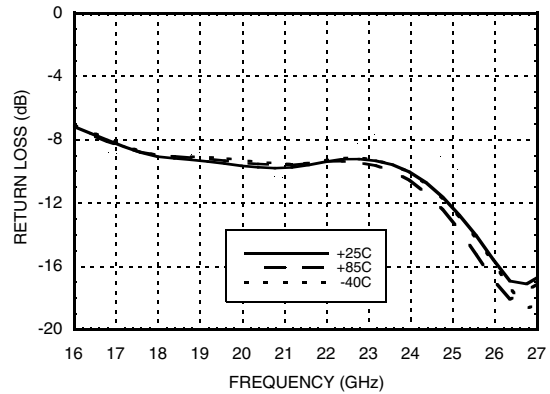

P1dB vs. Temperature

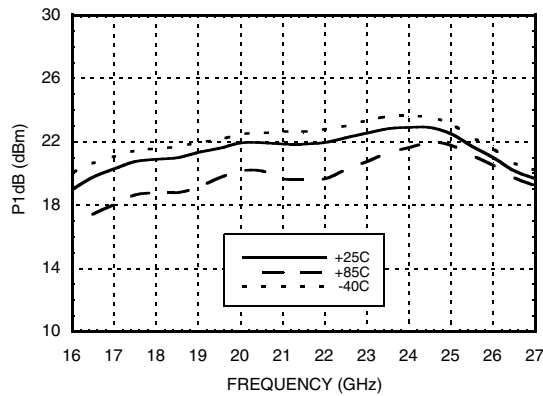

Psat vs. Temperature

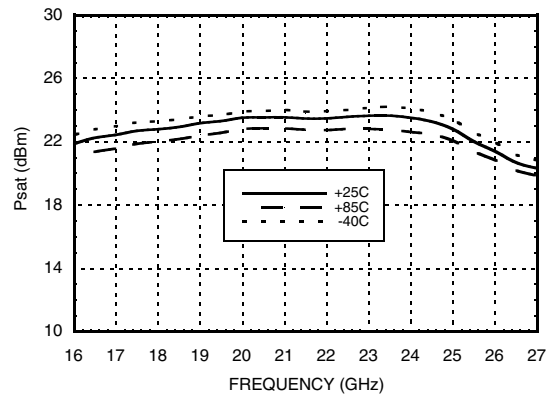



**GaAs PHEMT MMIC MEDIUM
POWER AMPLIFIER, 17.5 - 25.5 GHz**

LINEAR & POWER AMPLIFIERS - SMT

Power Compression @ 18 GHz

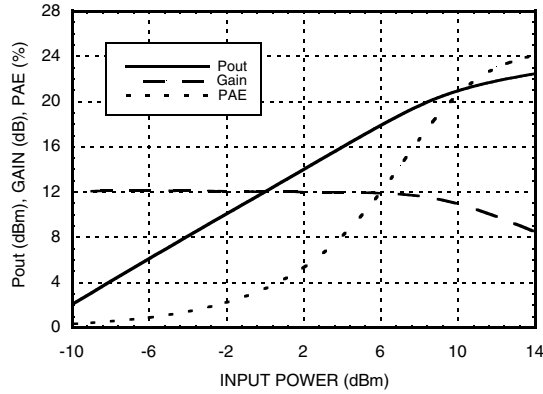

Power Compression @ 23 GHz

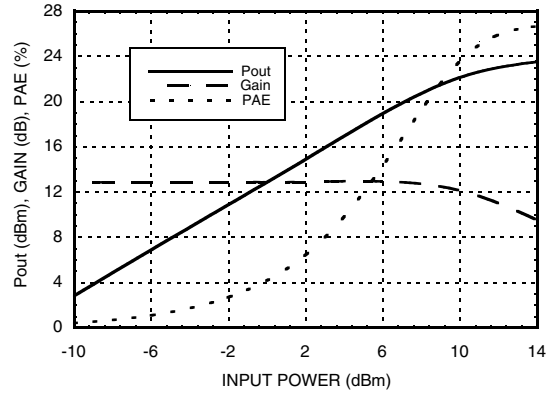

Output IP3 vs. Temperature

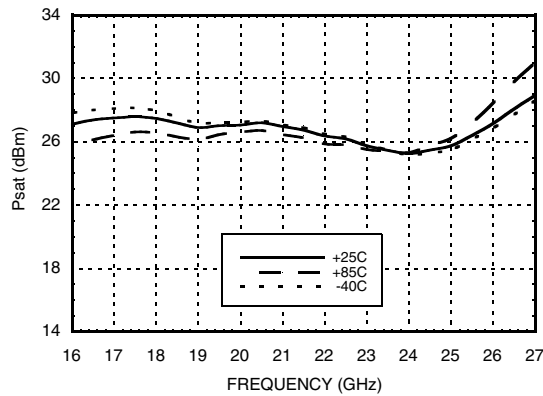

Noise Figure vs. Temperature

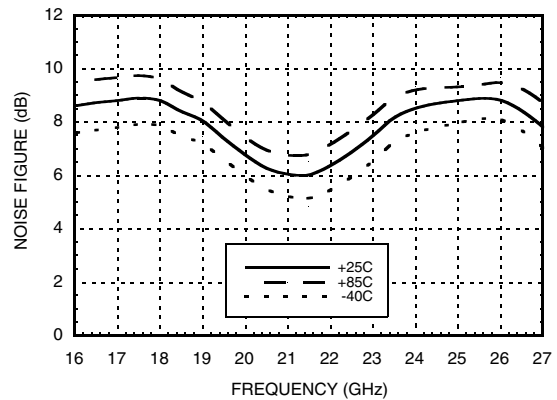

**Gain, Power and Output IP3 vs.
Supply Voltage @ 23 GHz**

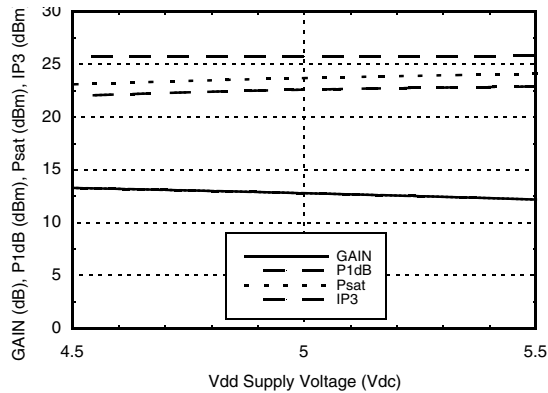

Reverse Isolation vs. Temperature

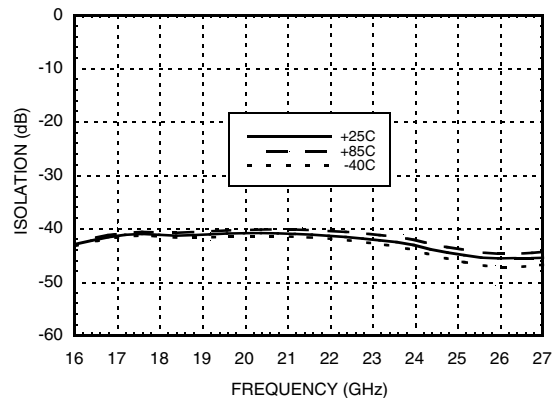

**GaAs PHEMT MMIC MEDIUM
POWER AMPLIFIER, 17.5 - 25.5 GHz**
Absolute Maximum Ratings

Drain Bias Voltage (Vdd)	+5.5 Vdc
Gate Bias Voltage (Vgg)	-8.0 to 0 Vdc
RF Input Power (RFIN)(Vdd = +5Vdc, Idd = 85 mA)	+16 dBm
Channel Temperature	175 °C
Continuous P _{diss} (T = 85 °C) (derate 5.46 mW/°C above 85 °C)	0.491 W
Thermal Resistance (channel to ground paddle)	183 °C/W
Storage Temperature	-65 to +150 °C
Operating Temperature	-40 to +85 °C
ESD Sensitivity (HBM)	Class 1A

Typical Supply Current vs. Vdd

Vdd (V)	Idd (mA)
+4.5	82
+5.0	84
+5.5	86

Note: Amplifier will operate over full voltage range shown above

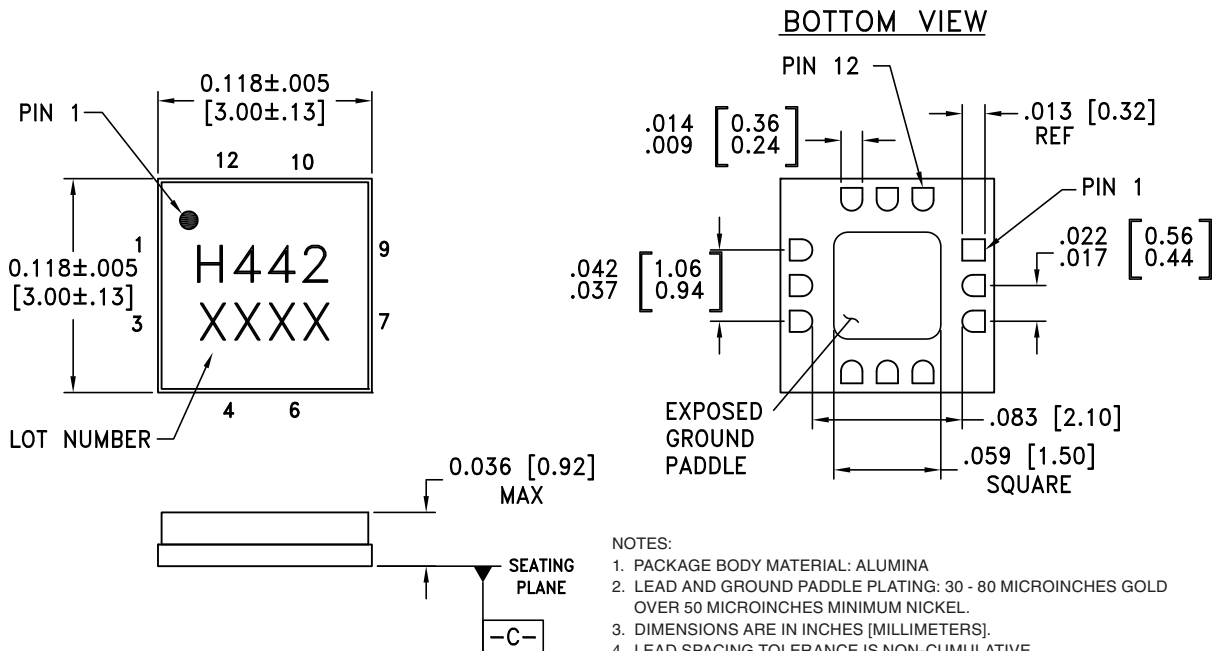
**ELECTROSTATIC SENSITIVE DEVICE
OBSERVE HANDLING PRECAUTIONS**
Outline Drawing

NOTES:

1. PACKAGE BODY MATERIAL: ALUMINA
2. LEAD AND GROUND PADDLE PLATING: 30 - 80 MICROINCHES GOLD OVER 50 MICROINCHES MINIMUM NICKEL.
3. DIMENSIONS ARE IN INCHES [MILLIMETERS].
4. LEAD SPACING TOLERANCE IS NON-CUMULATIVE
5. PACKAGE WARP SHALL NOT EXCEED 0.05mm DATUM -C-
6. ALL GROUND LEADS AND GROUND PADDLE MUST BE SOLDERED TO PCB RF GROUND.

Package Information

Part Number	Package Body Material	Lead Finish	MSL Rating	Package Marking ^[2]
HMC442LC3B	Alumina, White	Gold over Nickel	MSL3 ^[1]	H442 XXXX

[1] Max peak reflow temperature of 260 °C

[2] 4-Digit lot number XXXX

Pin Descriptions

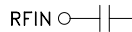
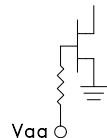
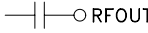
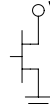
Pin Number	Function	Description	Interface Schematic
1, 3, 7, 9	GND	Package bottom must also be connected to RF/DC ground	
2	RFIN	This pin is AC coupled and matched to 50 Ohms.	
4, 6, 10, 12	N/C	This pin may be connected to RF/DC ground. Performance will not be affected.	
5	Vgg	Gate control for amplifier. Adjust to achieve Id of 84 mA. Please follow "MMIC Amplifier Biasing Procedure" Application Note.	
8	RFOUT	This pin is AC coupled and matched to 50 Ohms.	
11	Vdd	Power Supply Voltage for the amplifier. External bypass capacitors are required.	

Application Circuit

Component	Value
C1, C2	100 pF
C3, C4	1,000 pF
C5, C6	2.2 μ F

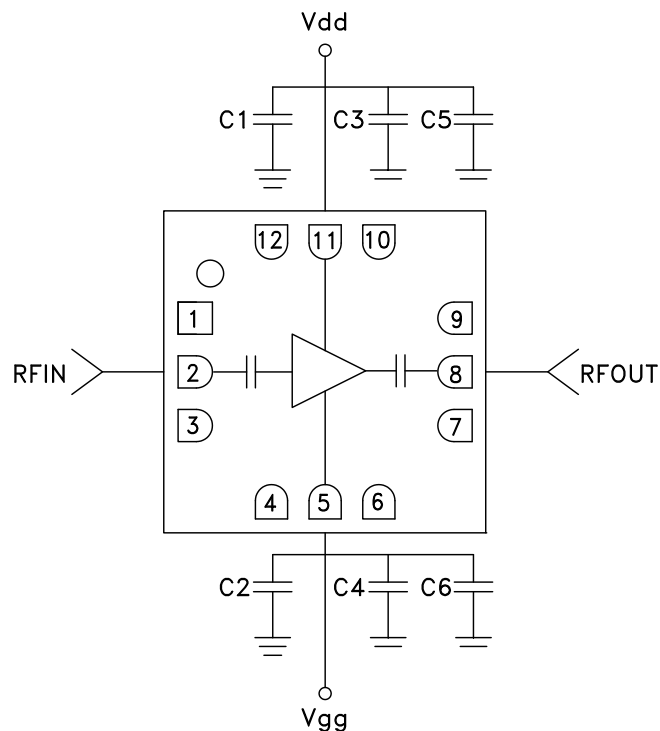

Evaluation PCB

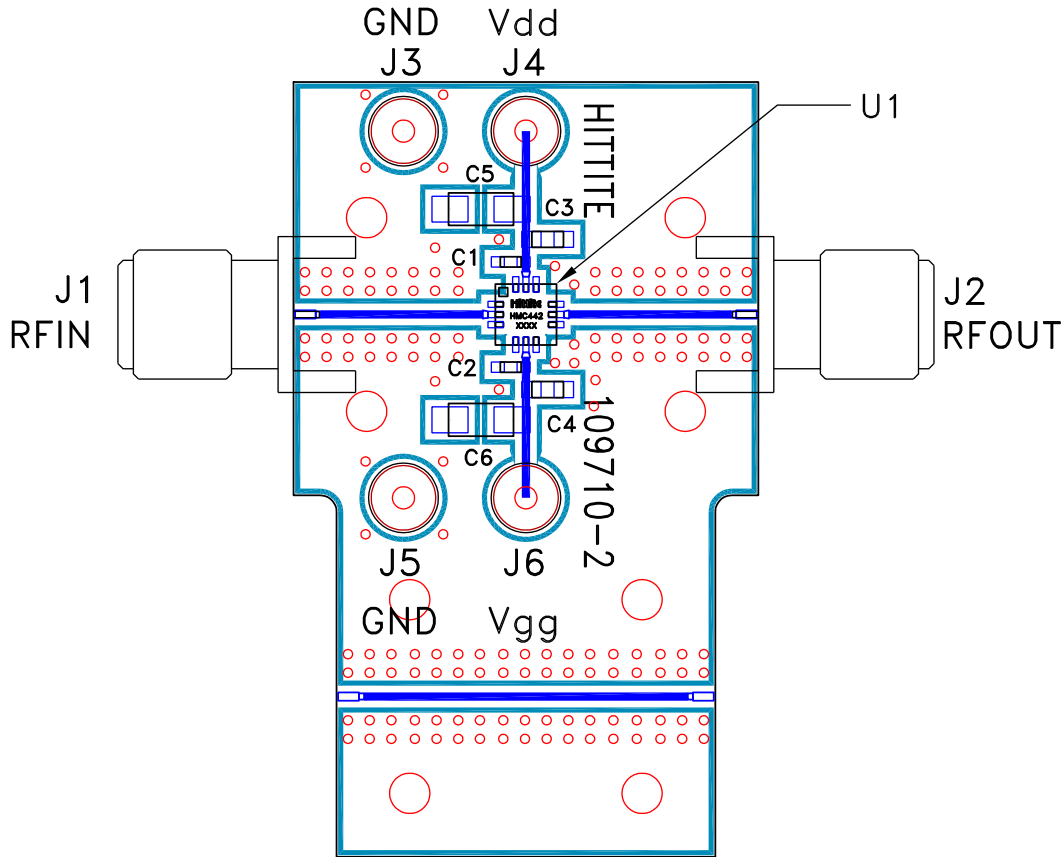

List of Materials for Evaluation PCB 109712 [1]

Item	Description
J1 - J2	PCB Mount SMA Connector
J3 - J6	DC Pin
C1 - C2	100 pF Capacitor, 0402 Pkg.
C3 - C4	1000 pF Capacitor, 0603 Pkg.
C5 - C6	2.2 μF Capacitor, Tantalum
U1	HMC442LC3B Amplifier
PCB [2]	109710 Evaluation PCB

[1] Reference this number when ordering complete evaluation PCB

[2] Circuit Board Material: Rogers 4350

The circuit board used in the final application should use RF circuit design techniques. Signal lines should have 50 Ohm impedance while the package ground leads and exposed paddle should be connected directly to the ground plane similar to that shown. A sufficient number of via holes should be used to connect the top and bottom ground planes. The evaluation board should be mounted to an appropriate heat sink. The evaluation circuit board shown is available from Hittite upon request.